

TECHNICAL CHARACTERISTIC

TTAMO

Tam

Stainless Steel Stool

The TAM collection is based on the circle as the minimal unit of expression, an essential element that gives rise to organic and versatile configurations. Its modular design allows for an infinite number of compositions, from individual pieces to complex structures, fostering flexible connections between users. TAM is a customizable collection that adapts to every space and need, combining design with functionality.

DESIGNED BY NAHTRANG



ondarreta

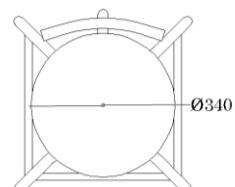
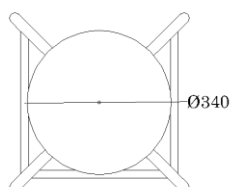
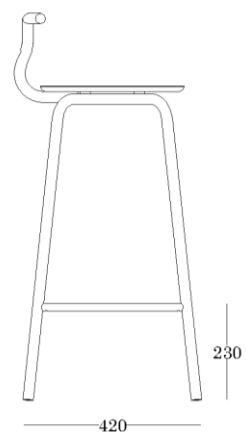
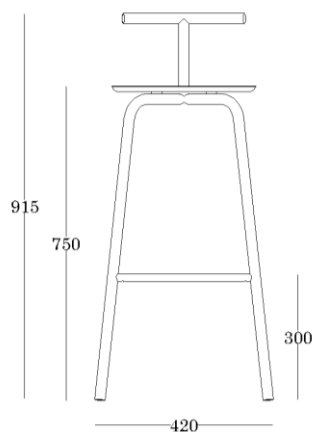
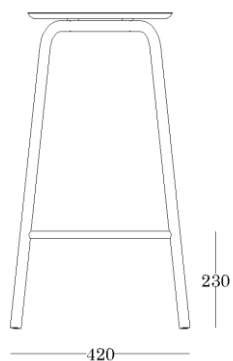
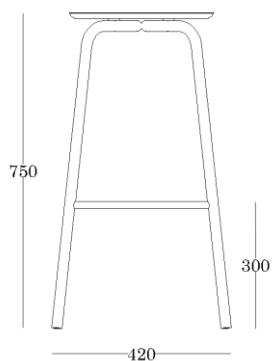
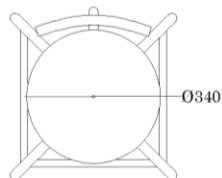
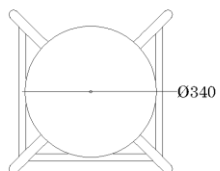
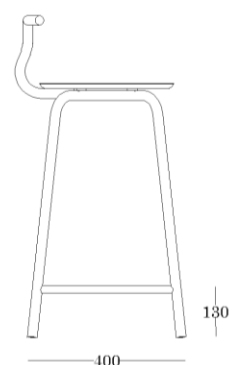
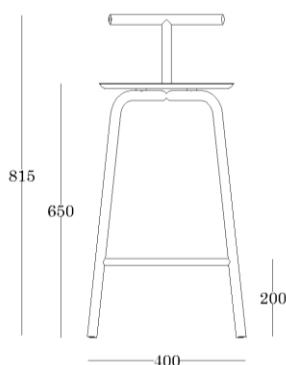
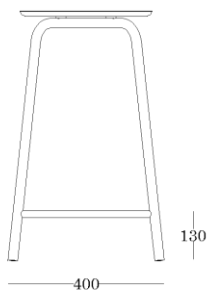
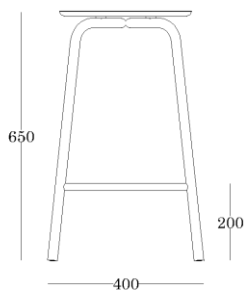
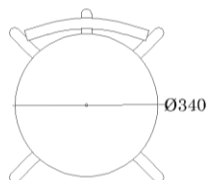
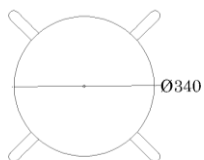
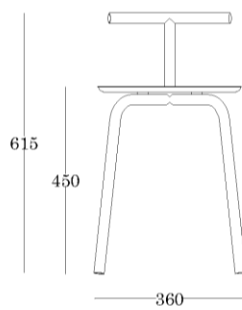
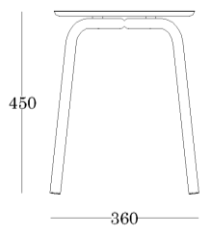

ondarreta

DIMENSIONS

H45:

36cm x 36 cm x 46 cm x 45 cm
(14.17" x 14.17" x 18.11" x 17.72")
[width x depth x height x seat
height]

H45 with backrest:

36cm x 41 cm x 63 cm x 45 cm
(14.17" x 16.14" x 24.80" x 17.72")
[width x depth x height x seat
height]

H65:

40cm x 40 cm x 66 cm x 65 cm x
20 cm (15.75" x 15.75" x 25.98" x
25.59" x 7.87") [width x depth x
height x seat height x footrest
height]

H65 with backrest:

40cm x 43 cm x 83 cm x 65 cm x
20 cm (15.75" x 16.93" x 32.68" x
25.59" x 7.87") [width x depth x
height x seat height x footrest
height]

H75:

42cm x 42 cm x 76 cm x 75 cm x
30 cm (16.54" x 16.54" x 29.92" x
29.53" x 11.81") [width x depth x
height x seat height x footrest
height]

H75 with backrest:

42cm x 44 cm x 93 cm x 75 cm x
30 cm (16.54" x 17.32" x 36.61" x
29.53" x 11.81") [width x depth x
height x seat height x footrest
height]

WEIGHT

H45 [without/with respaldo]:
4.2kg (9.26 lb) / 4.8kg (10.58 lb)

H65 [without/with respaldo]:
5.6kg (12.35 lb) / 6.2kg (13.67 lb)

H75 [without/with respaldo]:
6.1kg (13.45 lb) / 6.7 kg (14.77 lb)

PACKAGING

H45:

44 cm x 42 cm x 79 cm (17.32" x 16.54" x
31.10") (1 piece per box)

55.3 cm x 41 cm x 97.5 cm (21.77" x 16.14" x
38.39") (2 pieces per box)

H45 with backrest:

44 cm x 42 cm x 79 cm (17.32" x 16.54" x 31.10")
(1 piece per box)

55.3 cm x 41 cm x 97.5 cm (21.77" x 16.14" x 38.39")
pieces per box)

H65:

44 cm x 42 cm x 79 cm (17.32" x 16.54" x 31.10")
(1 piece per box)

H65 with backrest:

44 cm x 42 cm x 90 cm (17.32" x 16.54" x 35.43")
(1 piece per box)

H75:

44 cm x 42 cm x 90 cm (17.32" x 16.54" x 35.43")
(1 piece per box)

H75 with backrest:

55.3 cm x 45 cm x 97.5 cm (21.77" x 17.72" x 38.39")
(1 piece per box)

CERTIFICATION

Product tested under the European standard EN
16139:2013, category of general use L2.

ACCESORIES

Cushion

Backrest

ORIGIN

100% Made in Europe

DESIGN

Nahtrang



COMPONENTS

FRAME

Material

Precision cylindrical tube, 25 mm (0.98") in diameter and 2 mm (0.08") thick, made of AISI 304 stainless steel (in accordance with Standard EN-10296-2).

Tensile strength > 656 N/mm² (95.100 psi);

Elastic limit > 292 N/mm² (42.374 psi); Elongation > 60%

Footrest made of precision cylindrical tubing, 18 mm (0.71") in diameter and 2 mm (0.08") thick, in AISI 304 stainless steel (in accordance with Standard EN 10296-2).

Tensile strength > 641 N/mm² (92.960 psi);

Elastic limit > 319 N/mm² (46.270 psi); Elongation > 58%

Finish

Stainless steel

SEAT

Stainless steel + compact

Brushed stainless steel sheet on compact board with a diameter of 340 mm (13.39") and a thickness of 10 mm (0.40"), consisting internally of paper fibres treated with thermosetting resins, compressed at high pressures and temperatures and coated with natural wood or melamine sheets, CNC machined with rounded edges.

Finish

Stainless steel

ACCESORIES

BACKREST

Easily mountable and removable accessory created from a curved precision cylindrical tube with a diameter of 25 mm and a thickness of 2 mm in AISI 304 stainless steel (according to Standard EN-10296-2).

Tensile strength > 647 N/mm² (92.960 psi);

Elastic limit > 296 N/mm² (42.920 psi); Elongation > 54%

Finish

Stainless steel

COM REQUIREMENTS

Cushion: 40 cm (15.75")

