



ARMONY CENTRAL



Removable Cover
Sustainable
Product



Omologato IIM
Certificate
CRIB 5/CAL TB117

Internal structure: The structure of the body is in solid wood and curved plywood. Expanded polyurethane foam with dacron.

Struttura interna: *Struttura della scocca in legno massello e composito curvato, imbottitura in poliuretano espanso e dacron.*

Type of foam: Polyurethane foam with density of 40 and 35 kg/mc. It's fireproof based on:
• Italian class IIM: UNI9175/2010
• CRIB 5

Imbottitura: *Poliuretano espanso di densità 40 e 35 kg/mc. È ignifugo secondo le seguenti normative:*
• *Classe IIM italiana: UNI9175/2010*
• *CRIB 5*

Homologation: **Approved according to the following regulations in Italian Class IIM (UNI9175/2010) with certain upholstery materials**

Omologazione: **Omologato secondo le seguenti normative in Classe IIM italiana (UNI9175/2010) con determinati rivestimenti**

Base and finishing: Legs available in upholstered or varnished metal. Available metal finishes: standard, special, and RAL colors.

Basamento e finiture: *Gambe rivestite o in metallo verniciato. Finiture disponibili metallo: standard, special e Colori RAL*

Weight/Peso: 50 kg

Packaging /Imballo: 125x85 h 85 cm approx/approssimato

Volume 0.90 mc



FABRIC NEED AND UPHOLSTERY OPTIONS / CONSUMI E OPZIONI DI TAPPEZZERIA

01	02	03	04
Option 1	Option 2	Option 3	Option 4
unique fabric / tessuto unico	one fabric for the backrest and cushion and another for the rest / un tessuto per la schiena e cuscino e un altro per il restante	one fabric for the backrest, cushion and lower base and another for the rest / un tessuto per la schiena, cuscini e seduta inferiore e un altro per il restante	one fabric for the backrest and legs and another for the rest / un tessuto per la schiena e gambe e un altro per il restante
complete sofa with upholstered legs / divano completo con gambe rivestite	backrest and cushion/ schiena e cuscino	legs and upper seat/ gambe e seduta superiore	seat and cushion/ gambe e seduta
5,00 m.	legs and seat/ gambe e seduta	backrest, cushion and lower seat/ schiena, cuscini e seduta inferiore	backrest and legs/ schiena e gambe
	2,20 m.	3,20 m.	3,20 m.
	3,30 m.	3,40 m.	2,80 m.

NB: h fabric / tessuto 1,40 m.

N.B. For quantities over 5 pieces, please contact our commercial office to receive a more precise and accurate fabric consumption.
Per quantità superiori a n°5 pz, mettersi in contatto con il ns ufficio commerciale al fine di avere un metraggio più preciso e corretto.

USE AND MAINTENANCE / USO E MANUTENZIONE

- The product is intended for use in indoor environments.
- Avoid the use of solvents and abrasive
- Clean with soft cloths and neutral detergents. Treat stains promptly without rubbing, but dabbing.
- Regarding the maintenance and information related to the fabric, please contact directly the supplier since it is in COM.
- For further information, please see the supplier card.
- *Il prodotto è destinato per l'utilizzo in ambienti all'interno.*
- *Evitare l'impiego di solventi ed abrasivi.*
- *Pulire con panni morbidi e detergenti neutri. Trattare le macchie tempestivamente senza stronfinare ma tamponando.*
- *Per quanto riguarda la manutenzione e le informazioni relative al tessuto essendo in COM contattare direttamente il fornitore.*
- *Per maggiori informazioni vedi schede vostro fornitore*



TECHNICAL DRAWING / DISEGNI TECNICI

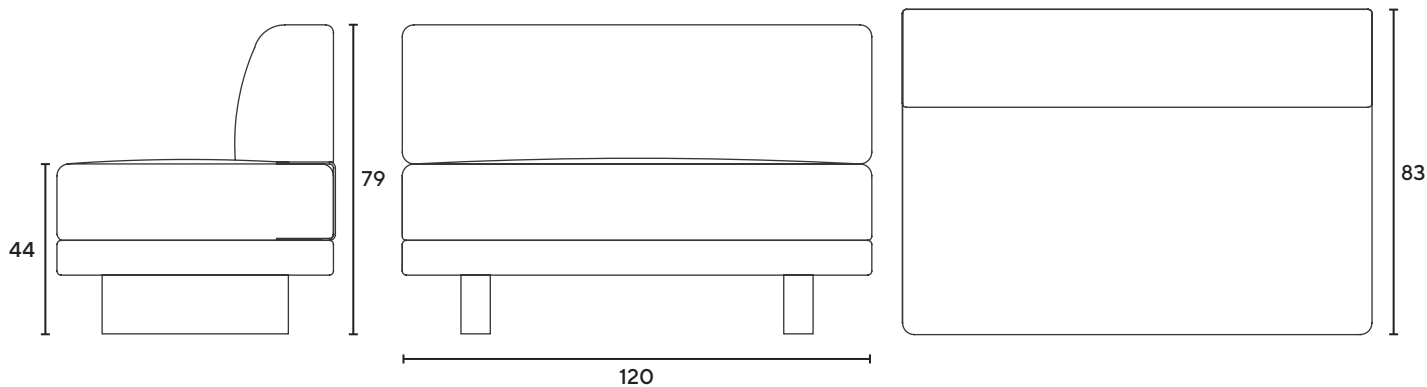

DIMENSIONS / DIMENSIONI:

W/L. 120 - D/Prof. 83 - HT. 79 - HS. 44 cm

Dimensions have a tolerance of ± 2 cm.

Le dimensioni hanno una tolleranza di ± 2 cm

METAL BASE FINISHING / FINITURE BASI METALLO

METAL STANDARD FINISHING / FINITURE METALLO STANDARD



BLACK
NERO

SPECIAL FINISHING / FINITURE SPECIALI



ASPHALT



CHAMPAGNE

RAL COLOURS / COLORI RAL



BLUE

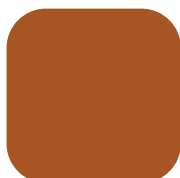

RUST



MUSTARD



OLIVE



GREY BEIGE



GREY MILK



GREY SHADE

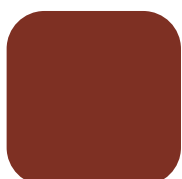

PORPURROT



CHOCOLATE



Finishing
Finiture



ARMONY CURVED



Removable Cover
Sustainable
Product



Omologato IIM
Certificate
CRIB 5 / CAL TB117

Internal structure: The structure of the body is in solid wood and curved plywood. Expanded polyurethane foam with dacron.

Struttura interna: *Struttura della scocca in legno massello e composito curvato, imbottitura in poliuretano espanso e dacron.*

Type of foam: Polyurethane foam with density of 40 and 35 kg/mc.
It's fireproof based on:
• Italian class IIM: UNI9175/2010
• CRIB 5

Imbottitura: *Poliuretano espanso di densità 40 e 35 kg/mc.
È ignifugo secondo le seguenti normative:
• Classe IIM italiana: UNI9175/2010
• CRIB 5*

Homologation: Approved according to the following regulations in Italian Class IIM (UNI9175/2010) with certain upholstery materials

Omologazione: *Omologato secondo le seguenti normative in Classe IIM italiana (UNI9175/2010) con determinati rivestimenti*

Base and finishing: Legs available in upholstered or varnished metal.
Available metal finishes: standard, special, and RAL colors.

Basamento e finiture: *Gambe rivestite o in metallo verniciato.
Finiture disponibili metallo: standard, special e Colori RAL*

Weight/Peso: 50 kg

Packaging /Imballo: 140x85 h 85 cm approx/ approssimato

Volume 1.05 mc

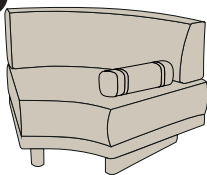
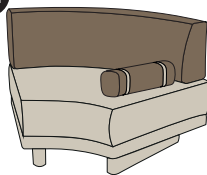
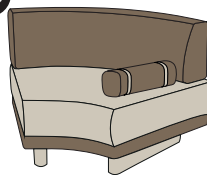
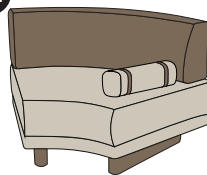

FABRIC NEED AND UPHOLSTERY OPTIONS / CONSUMI E OPZIONI DI TAPPEZZERIA

01	02	03	04
			
Option 1	Option 2	Option 3	Option 4
unique fabric / tessuto unico	one fabric for the backrest and cushion and another for the rest / un tessuto per la schiena e cuscino e un altro per il restante	one fabric for the backrest, cushion and lower base and another for the rest / un tessuto per la schiena, cuscini e seduta inferiore e un altro per il restante	one fabric for the backrest and legs another for the rest / un tessuto per la schiena e gambe e un altro per il restante
complete sofa with upholstered legs / divano completo con gambe rivestite	backrest and cushion/ schiena e cuscino	legs and upper seat/ gambe e seduta superiore	seat and cushion/ gambe e seduta
4,80 m.	legs and seat/ gambe e seduta	backrest, cushion and lower seat/ schiena, cuscini e seduta inferiore	backrest and legs/ schiena e gambe
	2,20 m.	2,80 m.	3,00 m.
	3,10 m.	2,60 m.	2,90 m.

NB: h fabric / tessuto 1,40 m.

N.B. For quantities over 5 pieces, please contact our commercial office to receive a more precise and accurate fabric consumption.
Per quantità superiori a n°5 pz, mettersi in contatto con il ns ufficio commerciale al fine di avere un metraggio più preciso e corretto.

USE AND MAINTENANCE / USO E MANUTENZIONE

- The product is intended for use in indoor environments.
- Avoid the use of solvents and abrasive
- Clean with soft cloths and neutral detergents. Treat stains promptly without rubbing, but dabbing.
- Regarding the maintenance and information related to the fabric, please contact directly the supplier since it is in COM.
- For further information, please see the supplier card.
- Il prodotto è destinato per l'utilizzo in ambienti all'interno.
- Evitare l'impiego di solventi ed abrasivi.
- Pulire con panni morbidi e detergenti neutri. Trattare le macchie tempestivamente senza strofinare ma tamponando.
- Per quanto riguarda la manutenzione e le informazioni relative al tessuto essendo in COM contattare direttamente il fornitore.
- Per maggiori informazioni vedi schede vostro fornitore



TECHNICAL DRAWING / DISEGNI TECNICI

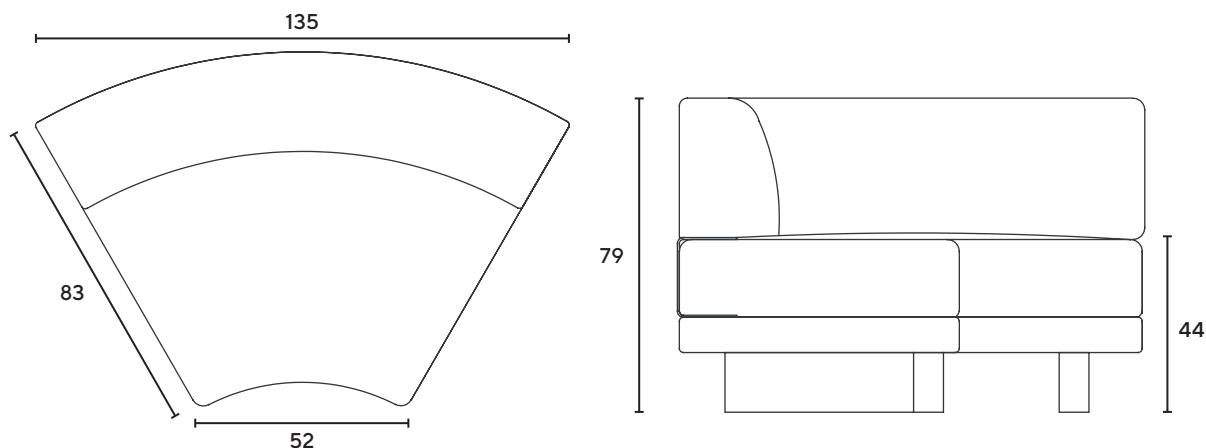

DIMENSIONS / DIMENSIONI:

W/L. 135 - D/Prof. 83 - HT. 79 - HS. 44 cm

Dimensions have a tolerance of ± 2 cm.

Le dimensioni hanno una tolleranza di ± 2 cm

METAL BASE FINISHING / FINITURE BASI METALLO

METAL STANDARD FINISHING / FINITURE METALLO STANDARD



BLACK
NERO

SPECIAL FINISHING / FINITURE SPECIALI



ASPHALT



CHAMPAGNE

RAL COLOURS / COLORI RAL



BLUE



RUST



MUSTARD



OLIVE



GREY BEIGE



GREY MILK



GREY SHADE

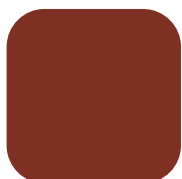

PORPURROT



CHOCOLATE



Finishing
Finiture